



Cambridge International AS & A Level

PHYSICS

9702/12

Paper 1 Multiple Choice

May/June 2020

1 hour 15 minutes

You must answer on the multiple choice answer sheet.

You will need: Multiple choice answer sheet
Soft clean eraser
Soft pencil (type B or HB is recommended)

INSTRUCTIONS

- There are **forty** questions on this paper. Answer **all** questions.
- For each question there are four possible answers **A, B, C** and **D**. Choose the **one** you consider correct and record your choice in soft pencil on the multiple choice answer sheet.
- Follow the instructions on the multiple choice answer sheet.
- Write in soft pencil.
- Write your name, centre number and candidate number on the multiple choice answer sheet in the spaces provided unless this has been done for you.
- Do **not** use correction fluid.
- Do **not** write on any bar codes.
- You may use a calculator.

INFORMATION

- The total mark for this paper is 40.
- Each correct answer will score one mark. A mark will not be deducted for a wrong answer.
- Any rough working should be done on this question paper.

This document has **24** pages. Blank pages are indicated.

Data

speed of light in free space	$c = 3.00 \times 10^8 \text{ m s}^{-1}$
permeability of free space	$\mu_0 = 4\pi \times 10^{-7} \text{ H m}^{-1}$
permittivity of free space	$\epsilon_0 = 8.85 \times 10^{-12} \text{ F m}^{-1}$ $(\frac{1}{4\pi\epsilon_0} = 8.99 \times 10^9 \text{ m F}^{-1})$
elementary charge	$e = 1.60 \times 10^{-19} \text{ C}$
the Planck constant	$h = 6.63 \times 10^{-34} \text{ J s}$
unified atomic mass unit	$1 \text{ u} = 1.66 \times 10^{-27} \text{ kg}$
rest mass of electron	$m_e = 9.11 \times 10^{-31} \text{ kg}$
rest mass of proton	$m_p = 1.67 \times 10^{-27} \text{ kg}$
molar gas constant	$R = 8.31 \text{ J K}^{-1} \text{ mol}^{-1}$
the Avogadro constant	$N_A = 6.02 \times 10^{23} \text{ mol}^{-1}$
the Boltzmann constant	$k = 1.38 \times 10^{-23} \text{ J K}^{-1}$
gravitational constant	$G = 6.67 \times 10^{-11} \text{ N m}^2 \text{ kg}^{-2}$
acceleration of free fall	$g = 9.81 \text{ m s}^{-2}$

Formulae

uniformly accelerated motion	$s = ut + \frac{1}{2}at^2$ $v^2 = u^2 + 2as$
work done on/by a gas	$W = p\Delta V$
gravitational potential	$\phi = -\frac{Gm}{r}$
hydrostatic pressure	$p = \rho gh$
pressure of an ideal gas	$p = \frac{1}{3}\frac{Nm}{V}\langle c^2 \rangle$
simple harmonic motion	$a = -\omega^2 x$
velocity of particle in s.h.m.	$v = v_0 \cos \omega t$ $v = \pm \omega \sqrt{(x_0^2 - x^2)}$
Doppler effect	$f_o = \frac{f_s v}{v \pm v_s}$
electric potential	$V = \frac{Q}{4\pi\epsilon_0 r}$
capacitors in series	$1/C = 1/C_1 + 1/C_2 + \dots$
capacitors in parallel	$C = C_1 + C_2 + \dots$
energy of charged capacitor	$W = \frac{1}{2}QV$
electric current	$I = Anvq$
resistors in series	$R = R_1 + R_2 + \dots$
resistors in parallel	$1/R = 1/R_1 + 1/R_2 + \dots$
Hall voltage	$V_H = \frac{BI}{ntq}$
alternating current/voltage	$x = x_0 \sin \omega t$
radioactive decay	$x = x_0 \exp(-\lambda t)$
decay constant	$\lambda = \frac{0.693}{t_{\frac{1}{2}}}$

1 What is a reasonable estimate of the mass of a raindrop?

- A 10^1 kg B 10^{-1} kg C 10^{-3} kg D 10^{-5} kg

2 Which quantity is a scalar?

- A acceleration
B force
C kinetic energy
D momentum

3 A galvanometer of resistance 5Ω is to be used in a null method.

In order to protect the galvanometer from damage due to an excessive initial current, resistors of resistance 0.5Ω and $1\text{ k}\Omega$ are available.

Which arrangement would provide this protection?

- A the 0.5Ω resistor in series with the galvanometer
B the 0.5Ω resistor in parallel with the galvanometer and this combination placed in series with the $1\text{ k}\Omega$ resistor
C the $1\text{ k}\Omega$ resistor in parallel with the galvanometer
D the $1\text{ k}\Omega$ resistor in parallel with the galvanometer and this combination placed in series with the 0.5Ω resistor

4 Readings are made of the current I for different voltages V across a fixed resistor. The results are plotted on a graph to show the variation of I with V .

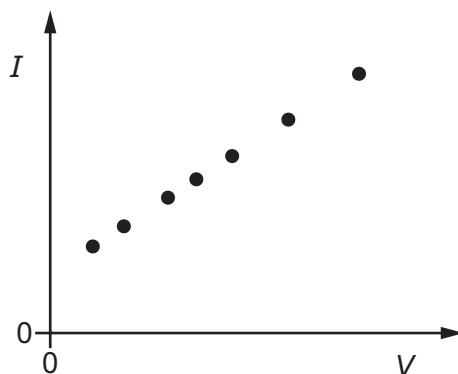

What is the best description of the errors in the readings?

- A both systematic and random
B neither systematic nor random
C random only
D systematic only

- 5 A stone is dropped from a height of 20 m above water. The graph shows the variation with time of the velocity of the stone.

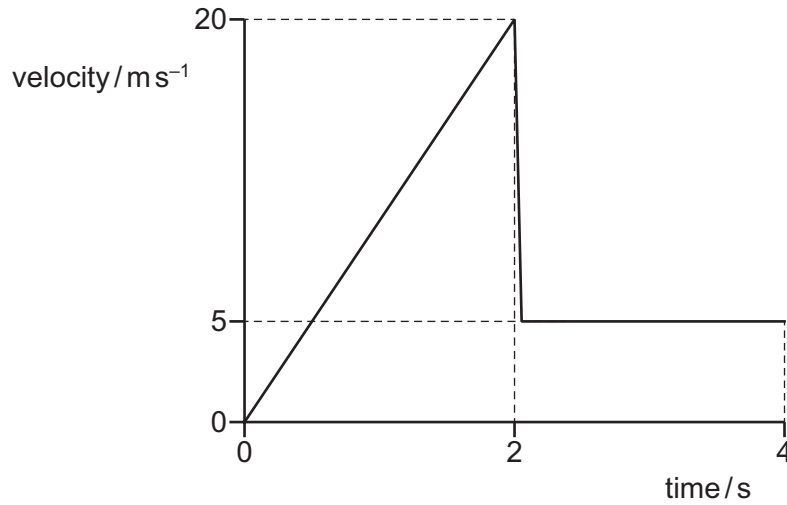

Which statement describes the approximate position of the stone four seconds after it is dropped?

- A It is at a distance of 10 m above the surface of the water.
- B It is at a distance of 10 m below the surface of the water.
- C It is at a distance of 20 m below the surface of the water.
- D It is at a distance of 30 m below the surface of the water.

- 6 A car X is travelling at a constant speed u along a straight road. At time $t = 0$ a second car Y is a distance d_0 behind car X and travelling at a speed v in the same direction. Speed v is less than speed u .

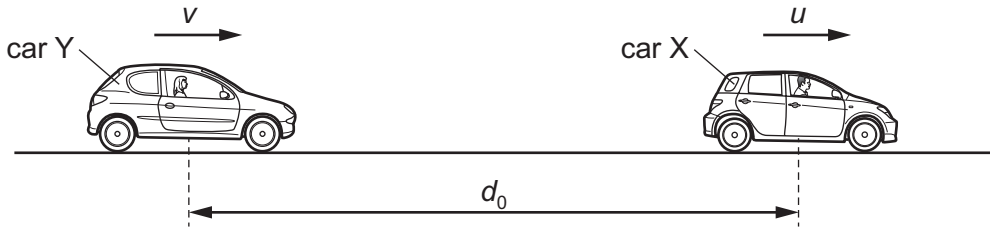

At time $t = 0$ car Y begins to accelerate with a constant acceleration.

Car Y overtakes car X at time $t = T$.

Which graph could best show the variation with time t of the distance d between the cars?

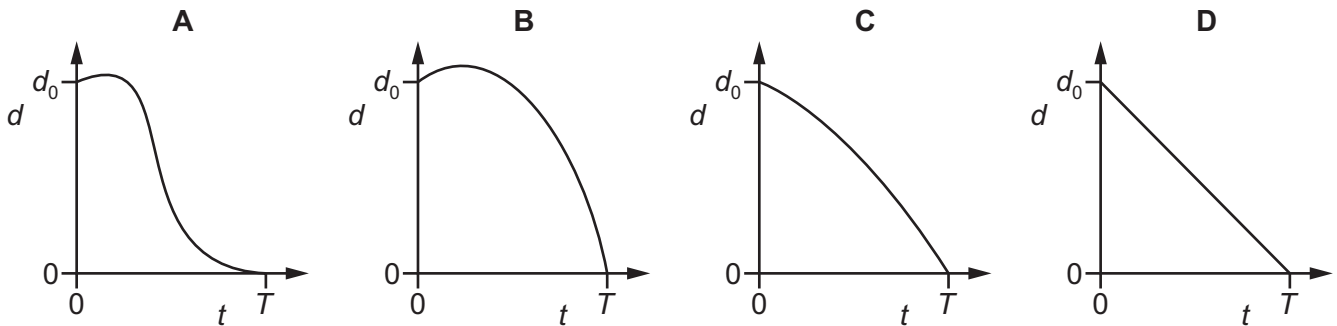

- 7 The resultant force acting on an object is slowly increased.

Which graph could show the variation with time t of the momentum p of the object?

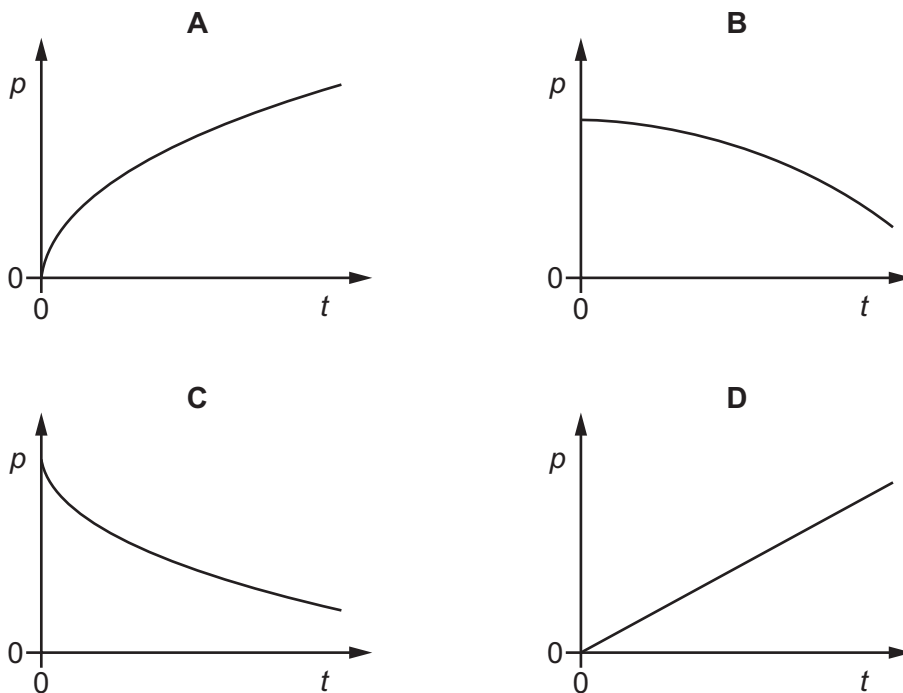

- 10 The diagrams show a negative electric charge situated in a uniform electric field and a mass situated in a uniform gravitational field.

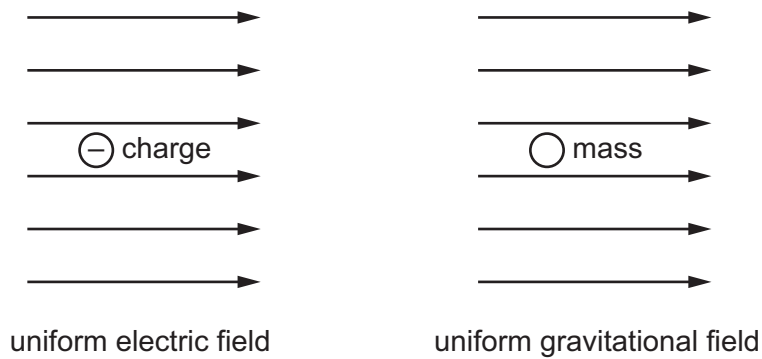

Which row shows the directions of the forces acting on the charge and on the mass?

	charge	mass
A		
B		
C		
D		

- 11 A bicycle pedal is connected to a pivot by a metal bar, as shown.

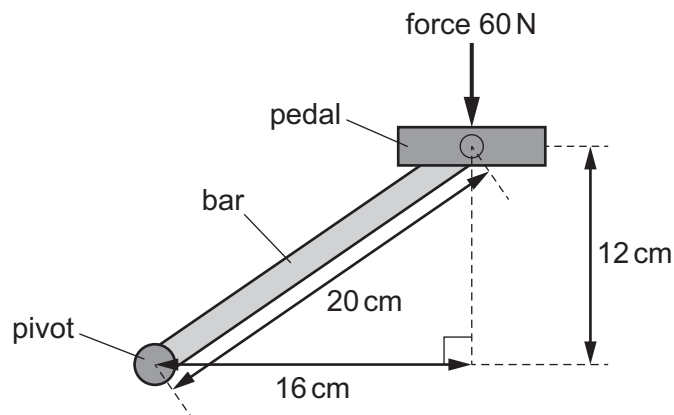

The force on the pedal is 60 N downwards.

What is the moment of this force about the pivot?

- A 7.2 N m B 9.6 N m C 12 N m D 1200 N m

- 12 A thin horizontal beam XY is freely hinged at point Y to a vertical wall. The beam is held stationary by a cable XZ which is attached to the wall at point Z.

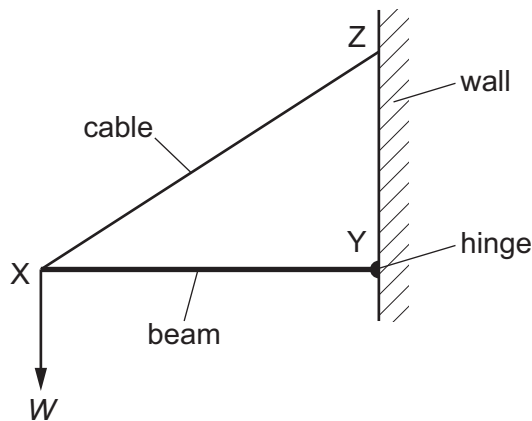

The beam supports a weight W at point X. The forces in the cable and the beam are F_C and F_B respectively.

Which vector triangle represents the forces acting on point X?

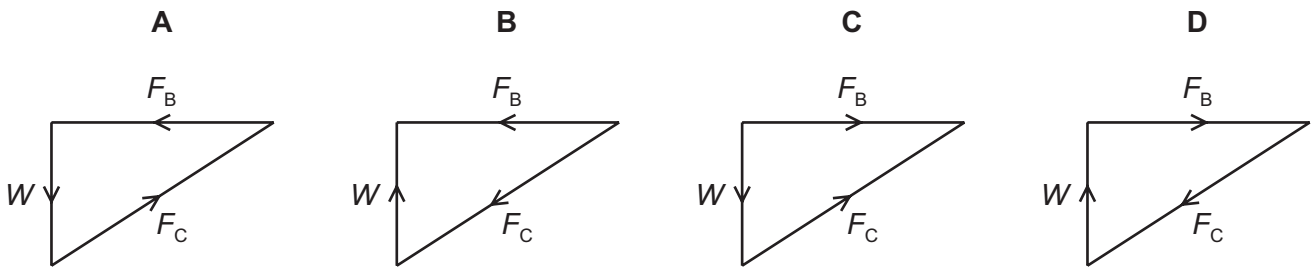

- 13 A pipe, open at one end, floats in a liquid as shown.

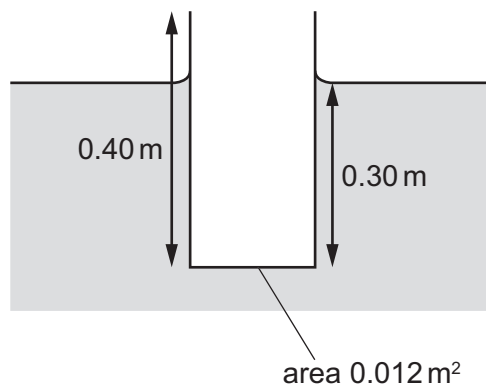

The cross-sectional area of the pipe is 0.012 m^2 . The weight of the pipe is 32 N .

What is the density of the liquid?

- A 680 kg m^{-3} B 910 kg m^{-3} C 6700 kg m^{-3} D 8900 kg m^{-3}

- 14 During an interval of time, fuel supplies energy X to a car.

Some of this energy is converted into kinetic energy as the car accelerates.

The rest of the energy Y is lost as thermal energy.

What is the efficiency of the car?

- A $\frac{X}{X-Y}$ B $\frac{Y}{X-Y}$ C $\frac{X-Y}{X}$ D $\frac{X-Y}{Y}$

- 15 In which situation is work done on an object?

- A The object slides with a constant velocity along a horizontal frictionless surface in a vacuum.
 B A person holds the object at arm's length and at a fixed height above the ground.
 C A person pushes the object up a frictionless ramp.
 D The stationary object floats partially submerged in water.

- 16 A spring is attached at one end to a fixed point. A mass is then hung from the other end of the spring. The spring has extension x when the system is in equilibrium.

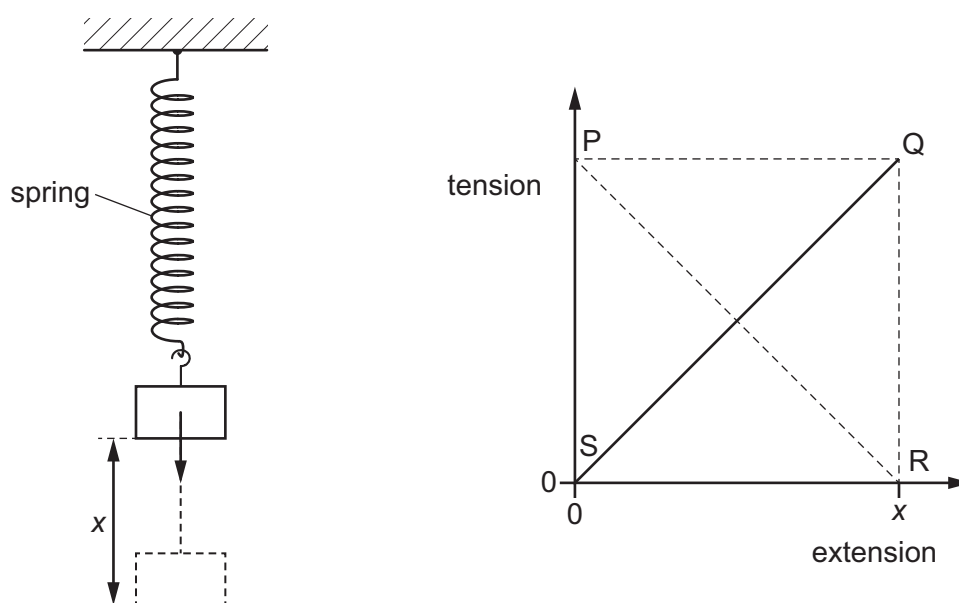

The variation of the tension in the spring with its extension is shown on the graph.

Which statement is correct?

- A Area SPR represents the energy stored in the spring which cannot be recovered.
 B Area SPQR represents the energy stored in the spring which can be recovered.
 C Area SPQ represents the loss of gravitational potential energy of the mass due to the extension of the spring.
 D Area SQR represents the elastic potential energy stored in the spring.

- 17 An escalator in an underground station has 25 people standing on it and is moving with a speed of 4.3 m s^{-1} . The average mass of a person is 78 kg and the angle of the escalator to the horizontal is 40° .

What is the minimum power required to lift these people?

- A 5.4 kW B 6.4 kW C 53 kW D 63 kW

- 18 An elastic cord of unstretched total length 16.0 cm and cross-sectional area $2.0 \times 10^{-6} \text{ m}^2$ is held horizontally by two smooth pins a distance 8.0 cm apart.

The cord obeys Hooke's law. A load of mass 0.40 kg is suspended centrally on the cord. The angle between the two sides of the cord supporting the load is 60° .

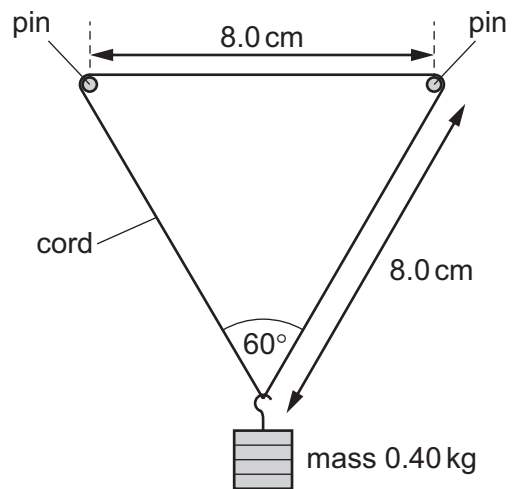
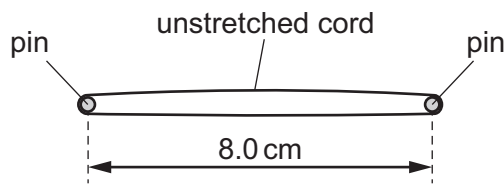

What is the Young modulus of the cord material?

- A $5.7 \times 10^5 \text{ Pa}$ B $1.1 \times 10^6 \text{ Pa}$ C $2.3 \times 10^6 \text{ Pa}$ D $3.9 \times 10^6 \text{ Pa}$

- 19 A student is investigating the mechanical properties of a metal. He applies different loads to a long thin wire up to its breaking point, and measures the extension of the wire for each load. He then plots a graph of stress against strain.

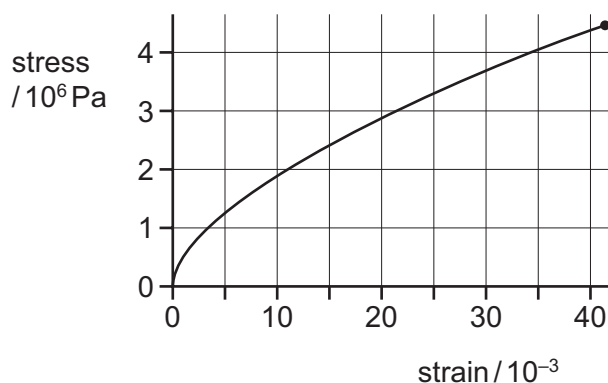

The student repeats the experiment with a wire made from the same metal, with twice the original length and half the diameter.

Which graph is obtained?

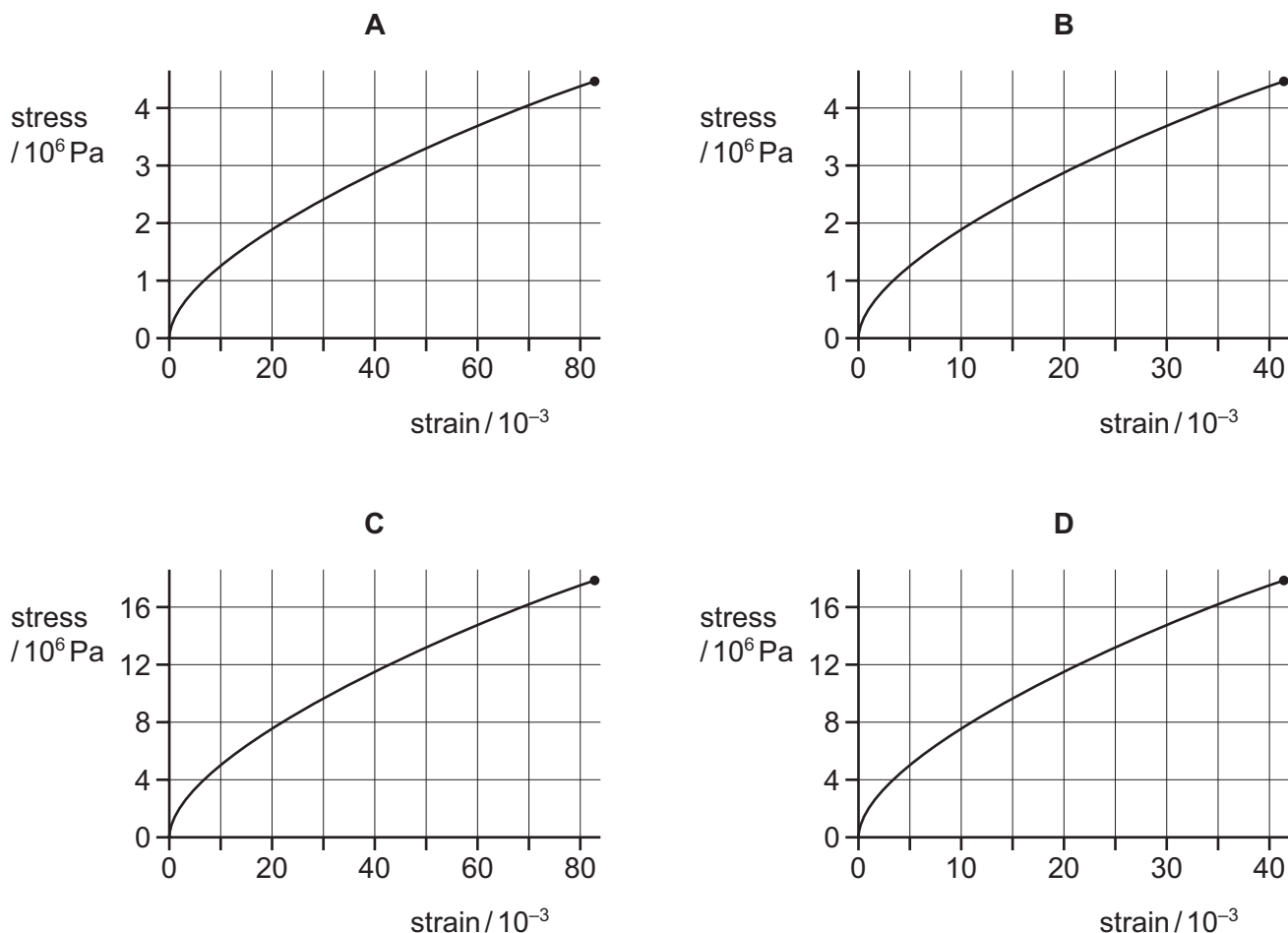

- 20 Which statement describes what is meant by the plastic deformation of a material?
- A It always obeys Hooke's law.
 B It does not return to its original length when the extending force is removed.
 C It never obeys Hooke's law.
 D It returns to its original length when the extending force is removed.
- 21 A transverse wave is moving along a rope. Two points X and Y on the rope are a quarter of a wavelength apart from each other.

Which statement is **not** possible for the two points X and Y at any instant?

- A They are both stationary.
 B They are displaced in opposite directions from their equilibrium position.
 C They are moving in opposite directions.
 D They both have displacements of the same magnitude from their equilibrium positions.
- 22 Two progressive waves meet at a fixed point P. The variation with time of the displacement of each wave at point P is shown in the graph.

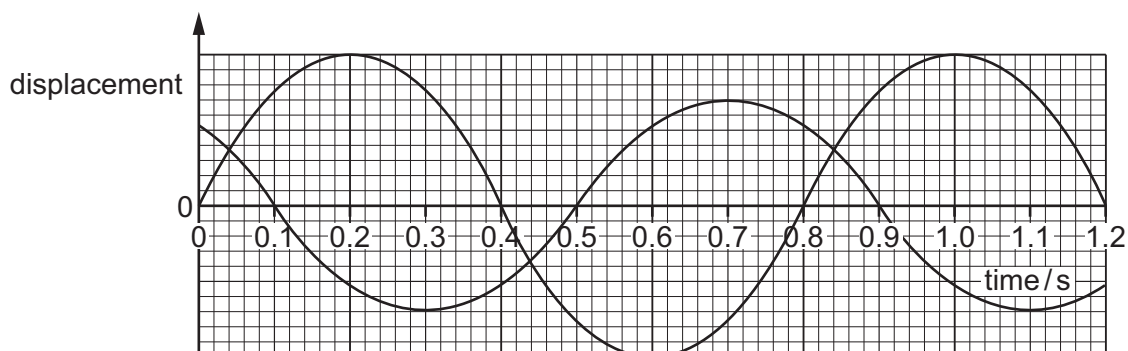

What is the phase difference between the two waves at point P?

- A 45° B 90° C 135° D 180°

- 23 A microphone connected to the Y-plates of a cathode-ray oscilloscope (CRO) is placed in front of a loudspeaker. The trace on the screen of the CRO is shown.

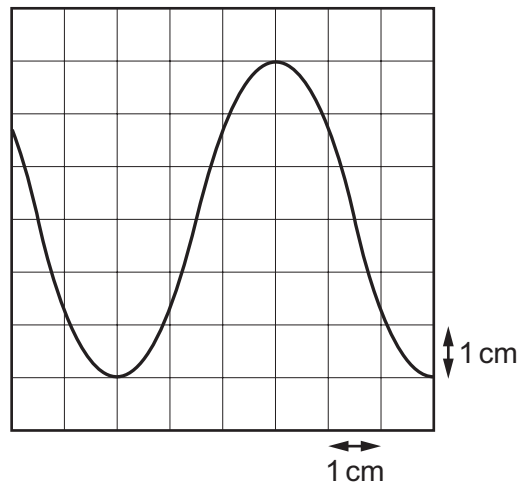

The time-base setting is 0.5 ms cm^{-1} and the Y-plate sensitivity is 0.2 mV cm^{-1} .

What is the frequency of the sound from the loudspeaker and what is the amplitude of the trace on the CRO?

	frequency / Hz	amplitude / mV
A	330	0.6
B	330	1.2
C	670	0.6
D	670	1.2

- 24 The diagram shows an experiment to produce a stationary wave in an air column. A tuning fork, placed above the column, vibrates and produces a sound wave. The length of the air column can be varied by altering the volume of the water in the tube.

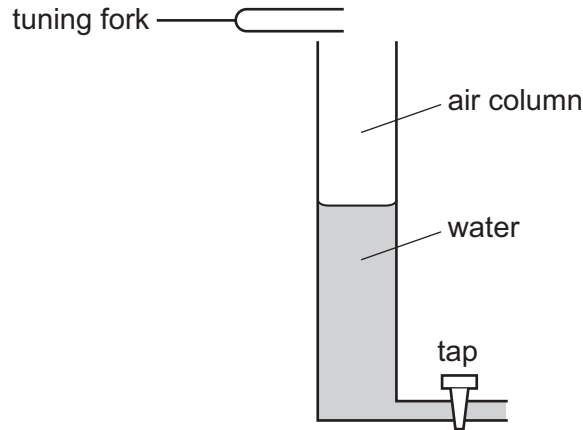

The tube is filled and then water is allowed to run out of it. The first two stationary waves occur when the air column lengths are 0.14 m and 0.42 m.

What is the wavelength of the sound wave?

- A** 0.14 m **B** 0.28 m **C** 0.42 m **D** 0.56 m
- 25 A stationary person measures the speed and wavelength of the sound from a horn on a stationary vehicle. The person then repeats the measurements when the vehicle is approaching at a constant speed.

Which row describes the measured wavelength and the measured speed of the sound wave from the moving vehicle when compared with the sound wave from the stationary vehicle?

	wavelength of the sound wave	speed of the sound wave
A	longer	greater
B	shorter	greater
C	longer	same
D	shorter	same

26 The table shows the wavelengths of five electromagnetic waves.

Which row correctly identifies the principal radiation for each of these wavelengths?

	10^{-14} m	10^{-10} m	10^{-6} m	10^{-2} m	10^2 m
A	gamma-ray	X-ray	infrared	microwave	radio wave
B	radio wave	microwave	infrared	X-ray	gamma-ray
C	radio wave	microwave	ultraviolet	infrared	X-ray
D	X-ray	infrared	ultraviolet	microwave	radio wave

27 Two progressive waves meet at a point.

Which condition must be met for superposition of the waves to occur?

- A** The waves must be coherent.
- B** The waves must be of the same type.
- C** The waves must be travelling in opposite directions.
- D** The waves must meet in phase.

28 A hill separates a television (TV) transmitter from a house. The transmitter cannot be seen from the house. However, the house has good TV reception.

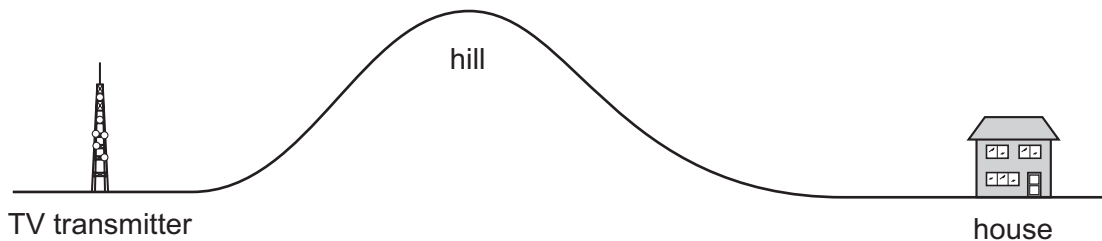

By which wave effect at the hill could the TV signal reach the house?

- A** coherence
- B** diffraction
- C** interference
- D** reflection

- 29 The diagram shows an arrangement for demonstrating two-source interference using coherent light of a single wavelength λ .

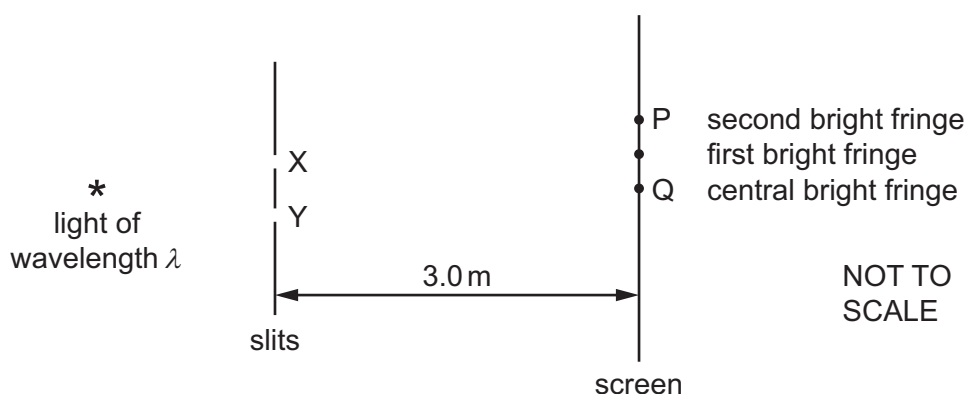

An interference pattern is observed on a screen 3.0 m away from the slits X and Y, which have a separation of 1.0 mm.

The central bright fringe is at Q, and the **second** bright fringe from the centre is at P.

What is the distance between Q and P?

- A $6.0 \times 10^3 \lambda$
 B $3.0 \times 10^3 \lambda$
 C $6.7 \times 10^{-4} \lambda$
 D $3.3 \times 10^{-4} \lambda$
- 30 Light of wavelength λ is incident normally on a diffraction grating. The angle between the **second**-order maximum and the normal to the grating is θ . The variation with $\sin \theta$ of λ is shown on the graph.

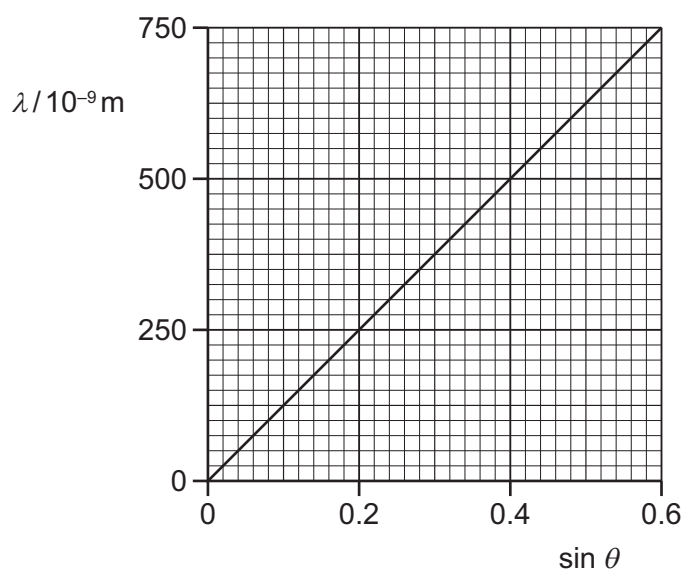

How many lines per millimetre are on the diffraction grating?

- A 400 mm^{-1} B 625 mm^{-1} C 800 mm^{-1} D 1250 mm^{-1}

- 31 A dipole is a pair of charges of equal magnitude, one negative and one positive. The electric field of a dipole is shown below.

In which direction does the force act on an electron when at point X?

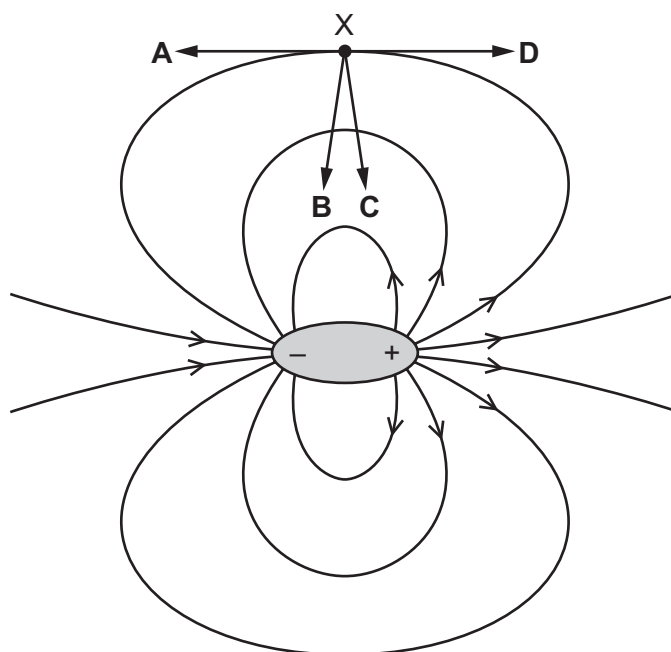

- 32 A charged oil droplet of mass m is falling, initially freely, in a vacuum between two horizontal metal plates that are separated by a distance x .

A potential difference (p.d.) V is then applied across the plates. This results in the oil droplet continuing to accelerate downwards but with a reduced acceleration a .

The polarity of the applied p.d. is then reversed so that the direction of the electric force on the droplet is reversed. This results in the downwards acceleration of the oil droplet increasing to $3a$.

What is the magnitude of the charge on the oil droplet?

- A $\frac{max}{V}$ B $2\frac{max}{V}$ C $3\frac{max}{V}$ D $4\frac{max}{V}$
- 33 The number density of free electrons in copper is $8.0 \times 10^{28} \text{ m}^{-3}$.

A copper wire has diameter 0.42 mm.

What is the average drift speed of the free electrons in the wire when the current in the wire is 0.57 A?

- A $8.0 \times 10^{-11} \text{ ms}^{-1}$
 B $3.2 \times 10^{-10} \text{ ms}^{-1}$
 C $8.0 \times 10^{-5} \text{ ms}^{-1}$
 D $3.2 \times 10^{-4} \text{ ms}^{-1}$

- 34 An electric kettle is rated at 2.0 kW, which describes the power supplied to the heating coil in the kettle.

The coil has a resistance of 5.0 k Ω .

What is the current in the coil?

- A 0.40 A B 0.63 A C 1.6 A D 2.5 A

- 35 A conductor consists of three wires connected in series. The wires are all made of the same metal but have different cross-sectional areas. There is a current I in the conductor.

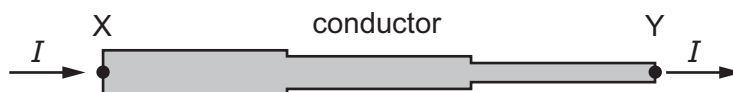

Point Y on the conductor is at zero potential.

Which graph best shows the variation of potential V with distance along the conductor?

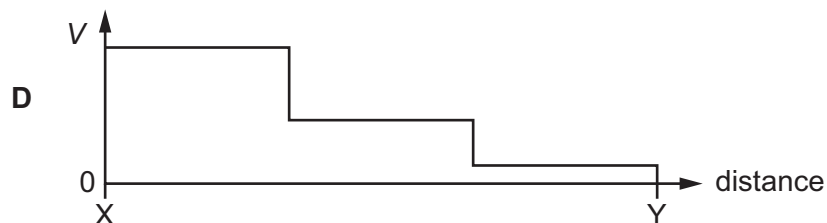
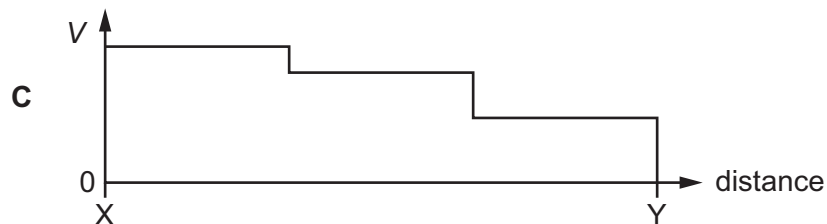
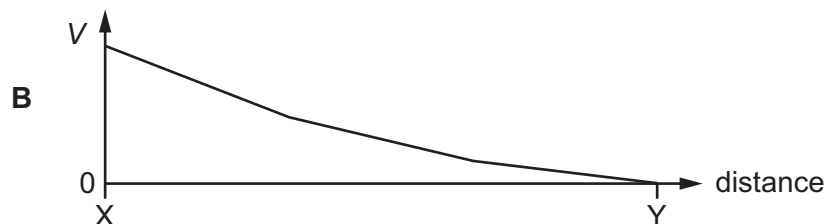
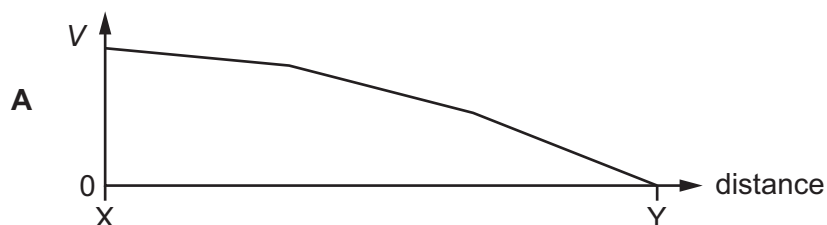

- 36 A cell of electromotive force (e.m.f.) E and internal resistance $0.50\ \Omega$ is connected to a resistor of resistance $4.7\ \Omega$.

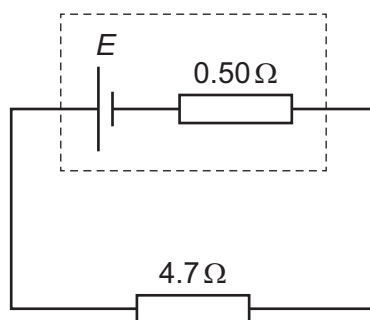

The maximum power that can be dissipated by the resistor without overheating is $0.50\ \text{W}$.

What is the maximum value of E for the resistor **not** to overheat?

- A** $1.4\ \text{V}$ **B** $1.5\ \text{V}$ **C** $1.7\ \text{V}$ **D** $2.9\ \text{V}$
- 37 Kirchhoff's first and second laws link to the conservation of physical quantities.

Which quantities do they link to?

	first law	second law
A	charge	energy
B	charge	momentum
C	energy	charge
D	energy	momentum

- 38 In the circuit shown, X is a variable resistor whose resistance can be changed from 5.0Ω to 500Ω . The electromotive force (e.m.f.) of the battery is 12.0V . It has negligible internal resistance.

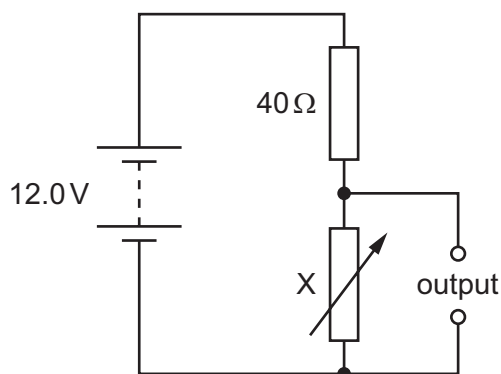

What is the maximum range of values of potential difference across the output?

- A 1.3V to 11.1V
 B 1.3V to 12.0V
 C 1.5V to 11.1V
 D 1.5V to 12.0V
- 39 An unstable nucleus goes through successive decays to become a final, stable nucleus. The initial nucleus and the final nucleus are isotopes of each other. How many α and β^- particles could have been emitted during the decay sequence?

	particle	
	α	β^-
A	1	0
B	1	2
C	2	0
D	2	1

- 40 A hadron has a charge of $-e$ and is composed of three quarks.

What could be the quark composition of the hadron?

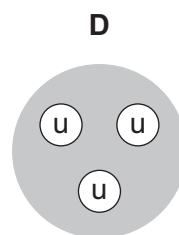
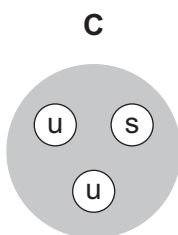
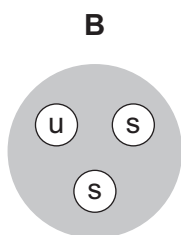
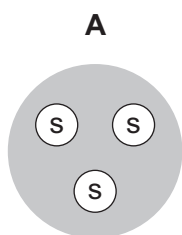

key

u = up quark
 s = strange quark

BLANK PAGE

Permission to reproduce items where third-party owned material protected by copyright is included has been sought and cleared where possible. Every reasonable effort has been made by the publisher (UCLES) to trace copyright holders, but if any items requiring clearance have unwittingly been included, the publisher will be pleased to make amends at the earliest possible opportunity.

To avoid the issue of disclosure of answer-related information to candidates, all copyright acknowledgements are reproduced online in the Cambridge Assessment International Education Copyright Acknowledgements Booklet. This is produced for each series of examinations and is freely available to download at www.cambridgeinternational.org after the live examination series.

Cambridge Assessment International Education is part of the Cambridge Assessment Group. Cambridge Assessment is the brand name of the University of Cambridge Local Examinations Syndicate (UCLES), which itself is a department of the University of Cambridge.