



Cambridge Assessment International Education
Cambridge International General Certificate of Secondary Education

CHEMISTRY

0620/21

Paper 2 Multiple Choice (Extended)

May/June 2019

45 minutes

Additional Materials: Multiple Choice Answer Sheet
Soft clean eraser
Soft pencil (type B or HB is recommended)



READ THESE INSTRUCTIONS FIRST

Write in soft pencil.

Do not use staples, paper clips, glue or correction fluid.

Write your name, centre number and candidate number on the Answer Sheet in the spaces provided unless this has been done for you.

DO NOT WRITE IN ANY BARCODES.

There are **forty** questions on this paper. Answer **all** questions. For each question there are four possible answers **A, B, C** and **D**.

Choose the **one** you consider correct and record your choice in **soft pencil** on the separate Answer Sheet.

Read the instructions on the Answer Sheet very carefully.

Each correct answer will score one mark. A mark will not be deducted for a wrong answer.

Any rough working should be done in this booklet.

A copy of the Periodic Table is printed on page 16.

Electronic calculators may be used.

This syllabus is regulated for use in England, Wales and Northern Ireland as a Cambridge International Level 1/Level 2 Certificate.

This document consists of **16** printed pages.

- 1 Which statement explains why ammonia gas, NH_3 , diffuses at a faster rate than hydrogen chloride gas, HCl ?
- A Ammonia expands to occupy all of the space available.
B Ammonia has a smaller relative molecular mass than hydrogen chloride.
C Ammonia is an alkali and hydrogen chloride is an acid.
D Ammonia molecules diffuse in all directions at the same time.
- 2 2.00 g of powdered calcium carbonate is added to 50.0 cm^3 of hydrochloric acid.

Which apparatus is used to measure the calcium carbonate and the hydrochloric acid?

	calcium carbonate	hydrochloric acid
A	balance	burette
B	balance	thermometer
C	pipette	burette
D	pipette	thermometer

- 3 The measurements from a chromatography experiment using substance F are shown. The diagram is not drawn to scale.

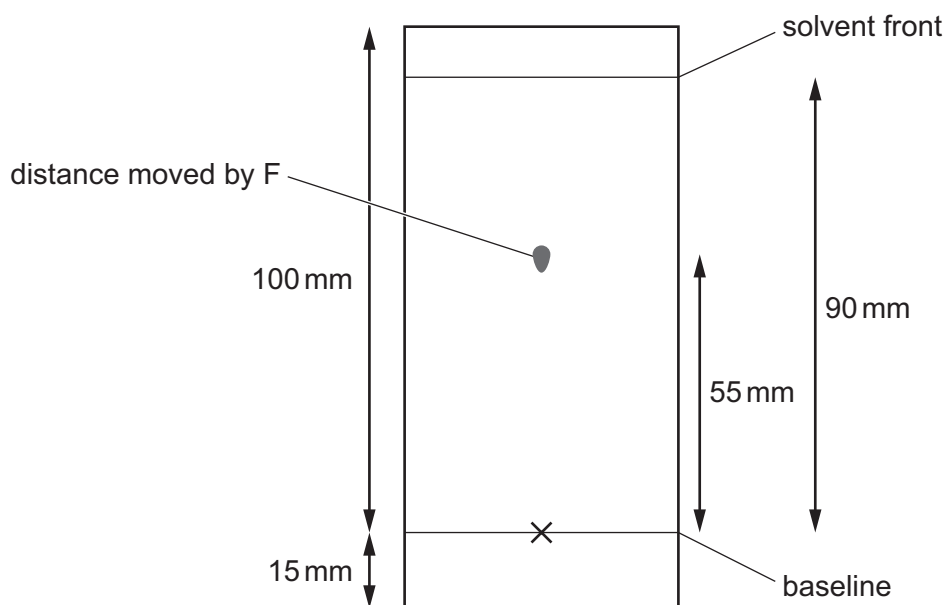

What is the R_f value of F?

- A 0.55 B 0.61 C 0.90 D 1.64

4 Which statement about an atom of fluorine, ${}^{19}_{9}\text{F}$, is correct?

- A It contains more protons than neutrons.
- B It contains a total of 28 protons, neutrons and electrons.
- C Its isotopes contain different numbers of protons.
- D Its nucleus contains 9 neutrons.

5 Which row describes the formation of single covalent bonds in methane?

A	atoms share a pair of electrons	both atoms gain a noble gas electronic structure
B	atoms share a pair of electrons	both atoms have the same number of electrons in their outer shell
C	electrons are transferred from one atom to another	both atoms gain a noble gas electronic structure
D	electrons are transferred from one atom to another	both atoms have the same number of electrons in their outer shell

6 Which statement describes the structure of an ionic compound?

- A It is a giant lattice of oppositely charged ions.
- B It is a giant lattice of positive ions in a 'sea' of electrons.
- C It is a giant molecule of oppositely charged ions.
- D It is a simple molecule of oppositely charged ions.

7 Propane burns in oxygen.

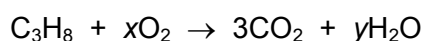

Which values of x and y balance the equation?

	x	y
A	5	4
B	7	4
C	10	8
D	13	8

- 8 A tablet contains 0.080 g of ascorbic acid ($M_r = 176$).

What is the concentration of ascorbic acid when one tablet is dissolved in 200 cm³ of water?

- A $9.1 \times 10^{-5} \text{ mol/dm}^3$
B $4.5 \times 10^{-4} \text{ mol/dm}^3$
C $9.1 \times 10^{-2} \text{ mol/dm}^3$
D $2.3 \times 10^{-3} \text{ mol/dm}^3$
- 9 Which statement about the electrolysis of copper(II) sulfate solution using carbon electrodes is correct?
- A A colourless gas is produced at the anode.
B A colourless gas is produced at the cathode.
C The colour of the electrolyte remains the same.
D The mass of both electrodes remains constant.
- 10 Aluminium metal is extracted from aluminium oxide by electrolysis.

Which ionic half-equation describes a reaction that occurs at the named electrode?

	ionic half-equation	electrode
A	$2\text{O}^{2-} \rightarrow \text{O}_2 + 2\text{e}^-$	anode
B	$\text{Al}^{3+} + 3\text{e}^- \rightarrow \text{Al}$	anode
C	$2\text{O}^{2-} \rightarrow \text{O}_2 + 4\text{e}^-$	cathode
D	$\text{Al}^{3+} + 3\text{e}^- \rightarrow \text{Al}$	cathode

- 11 Which statement about the hydrogen fuel cell is **not** correct?
- A Chemical energy is converted into electrical energy.
B Hydrogen is oxidised.
C The reaction that takes place is endothermic.
D Water is the only product.

12 Nitrogen reacts with hydrogen to produce ammonia.

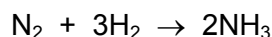

The reaction is exothermic. The bond energies are shown in the table.

bond	bond energy in kJ/mol
N≡N	945
H–H	436
N–H	390

What is the energy change for this reaction?

- A –1473 kJ/mol
 - B –87 kJ/mol
 - C 87 kJ/mol
 - D 1473 kJ/mol
- 13 Which change in reaction conditions increases both the collision rate and the proportion of molecules with sufficient energy to react?
- A addition of a catalyst
 - B increasing the concentration of a reactant
 - C increasing the surface area of a reactant
 - D increasing the temperature of the reaction
- 14 When blue-green crystals of nickel(II) sulfate are heated, water is produced and a yellow solid remains. When water is added to the yellow solid, the blue-green colour returns.

Which process describes these changes?

- A combustion
- B corrosion
- C neutralisation
- D reversible reaction

- 15 The graph shows how the yield of product in a reversible reaction changes as the temperature and pressure are changed.

All reactants and products are gases.

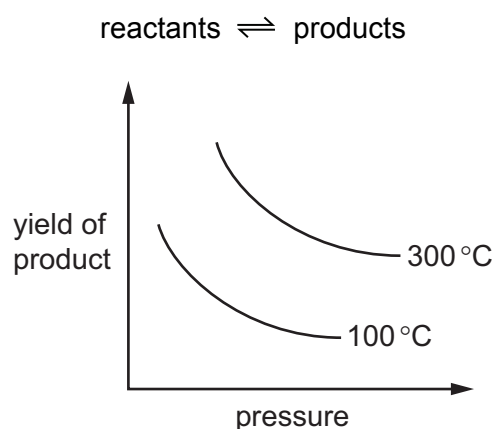

Which row is correct for this reversible reaction?

	side of reaction with fewer moles	forward reaction
A	reactant	exothermic
B	reactant	endothermic
C	product	endothermic
D	product	exothermic

- 16 Which changes represent oxidation?

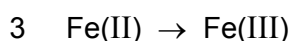
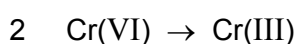
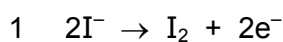

- A** 1 and 2 **B** 1 and 3 **C** 1 only **D** 2 only

- 17 Nitrogen(I) oxide, N_2O , nitrogen(II) oxide, NO , and carbon monoxide, CO , are all non-metal oxides.

They do not react with acids or bases.

Which statement is correct?

- A** They are acidic oxides.
B They are amphoteric oxides.
C They are basic oxides.
D They are neutral oxides.

24 Three metal compounds, P, Q and R, are heated using a Bunsen burner.

The results are shown.

P colourless gas produced, which relights a glowing splint

Q colourless gas produced, which turns limewater milky

R no reaction

Which row shows the identity of P, Q and R?

	P	Q	R
A	magnesium carbonate	potassium carbonate	potassium nitrate
B	magnesium carbonate	potassium nitrate	potassium carbonate
C	potassium nitrate	magnesium carbonate	potassium carbonate
D	potassium nitrate	potassium carbonate	magnesium carbonate

25 Zinc is extracted from its ore, zinc blende, using two chemical reactions.

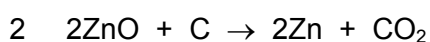
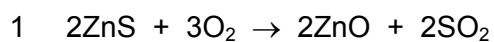

Which substance is reduced in reactions 1 and 2?

	reaction 1	reaction 2
A	O ₂	C
B	O ₂	ZnO
C	ZnS	C
D	ZnS	ZnO

- 26 Four metals, zinc, M, copper and magnesium, are reacted with aqueous solutions of their nitrates.

The results are shown.

metal	magnesium nitrate	M nitrate	copper nitrate	zinc nitrate	
magnesium		✓	✓	✓	key
zinc	X	✓	✓		✓ = reacts
M	X		✓	X	X = no reaction
copper	X	X		X	

What is the order of reactivity of these four metals starting with the most reactive?

- A copper → zinc → M → magnesium
B copper → M → zinc → magnesium
C magnesium → M → zinc → copper
D magnesium → zinc → M → copper
- 27 Why is aluminium used to make containers for storing food?

- A It conducts electricity.
B It has a high melting point.
C It is resistant to corrosion.
D It is strong.

- 28 Water can be treated by filtration then chlorination.

Which uses do **not** need water of this quality?

- 1 water for cooling in industry
2 water for washing clothes
3 water for drinking

- A 1, 2 and 3 B 1 and 2 only C 1 and 3 only D 2 and 3 only

29 Oxides of nitrogen are formed in car engines and are a source of air pollution.

To decrease this pollution, catalytic converters are fitted to car exhausts.

What happens to the oxides of nitrogen in the catalytic converter?

- A combustion
- B cracking
- C oxidation
- D reduction

30 The diagram shows an experiment to investigate how paint affects the rusting of iron.

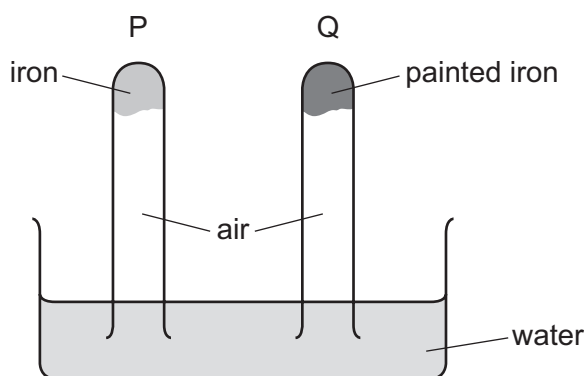

What happens to the water level in tubes P and Q?

	tube P	tube Q
A	falls	rises
B	no change	rises
C	rises	falls
D	rises	no change

31 Ammonia is manufactured by the Haber Process.

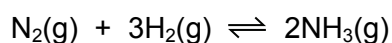

The forward reaction is exothermic.

Which conditions maximise the yield of ammonia?

	pressure	temperature
A	high	high
B	high	low
C	low	high
D	low	low

32 The carbon cycle is shown.

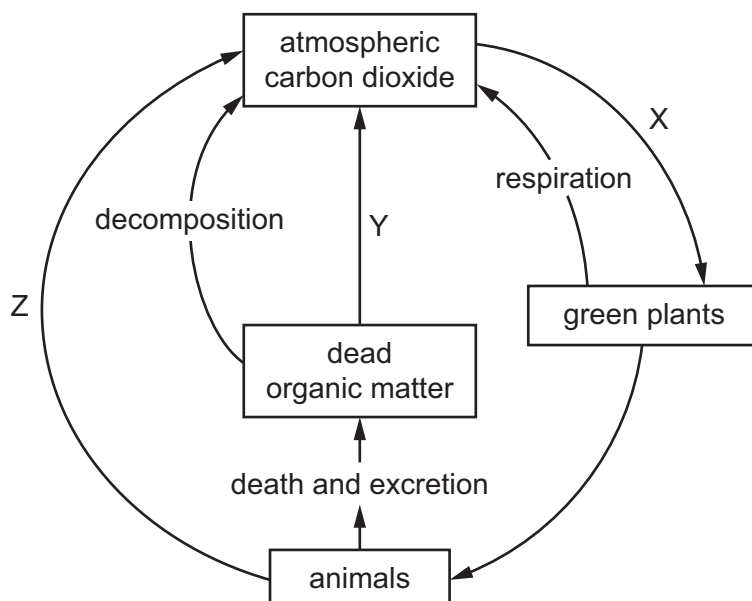

Which row describes processes X, Y and Z?

	X	Y	Z
A	respiration	combustion	photosynthesis
B	respiration	photosynthesis	combustion
C	photosynthesis	combustion	respiration
D	photosynthesis	respiration	combustion

33 Which row shows the conditions used in the Contact process?

	temperature / °C	pressure / atm	catalyst
A	25	2	iron
B	25	200	iron
C	450	2	vanadium(V) oxide
D	450	200	vanadium(V) oxide

34 The diagram represents a lime kiln used to heat limestone to a very high temperature.

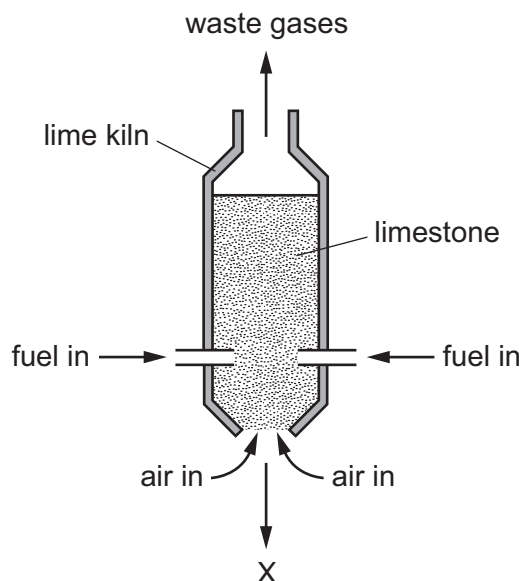

What leaves the kiln at X?

- A calcium carbonate
- B calcium hydroxide
- C calcium oxide
- D calcium sulfate

35 Which fuel could be gasoline?

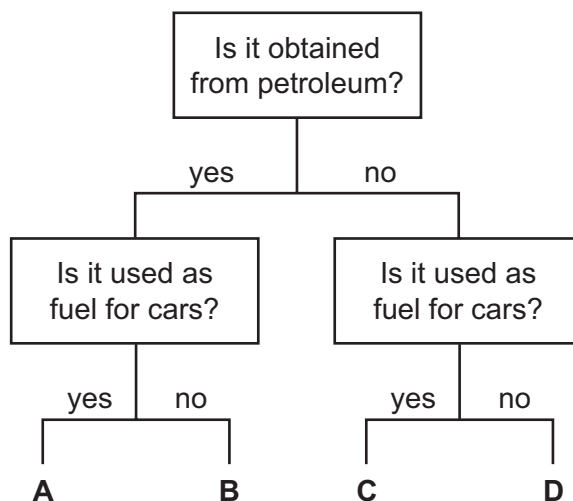

- 36 Why is ethanol a member of the homologous series of alcohols but propane is **not**?
- A Ethanol has two carbon atoms per molecule but propane has three.
 - B Ethanol can be made from ethene but propane is obtained from petroleum.
 - C Ethanol is a liquid but propane is a gas.
 - D Ethanol contains the same functional group as other alcohols but propane does not.

- 37 Chlorine reacts with methane.

Which statements are correct?

- 1 The reaction takes place in the dark.
- 2 The reaction of chlorine with methane forms chloromethane.
- 3 Chloromethane reacts with chlorine to produce dichloromethane.
- 4 The reaction of chlorine with methane is an addition reaction.

- A 1 and 2 B 1 and 3 C 2 and 3 D 3 and 4

- 38 Which statements about aqueous ethanoic acid are correct?

- 1 Ethanoic acid contains the functional group -COOH .
- 2 Ethanoic acid reacts with carbonates to produce hydrogen.
- 3 Ethanoic acid turns Universal Indicator paper blue.
- 4 Ethanoic acid has a pH lower than pH 7.

- A 1 and 2 B 1 and 3 C 1 and 4 D 2 and 4

- 39 The structure of an ester is shown.

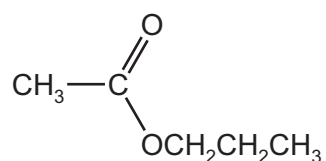

What is the name of the ester?

- A ethyl propanoate
- B methyl propanoate
- C propyl ethanoate
- D propyl methanoate

40 The structure of a polymer is shown.



Which type of polymer is shown and by which process is it formed?

	type of polymer	formed by
A	carbohydrate	addition polymerisation
B	carbohydrate	condensation polymerisation
C	polyester	addition polymerisation
D	polyester	condensation polymerisation

Permission to reproduce items where third-party owned material protected by copyright is included has been sought and cleared where possible. Every reasonable effort has been made by the publisher (UCLES) to trace copyright holders, but if any items requiring clearance have unwittingly been included, the publisher will be pleased to make amends at the earliest possible opportunity.

To avoid the issue of disclosure of answer-related information to candidates, all copyright acknowledgements are reproduced online in the Cambridge Assessment International Education Copyright Acknowledgements Booklet. This is produced for each series of examinations and is freely available to download at www.cambridgeinternational.org after the live examination series.

Cambridge Assessment International Education is part of the Cambridge Assessment Group. Cambridge Assessment is the brand name of the University of Cambridge Local Examinations Syndicate (UCLES), which itself is a department of the University of Cambridge.

The Periodic Table of Elements

		Group							
I	II	III	IV	V	VI	VII	VIII		
3 Li lithium 7	4 Be beryllium 9	1 H hydrogen 1	5 B boron 11	6 C carbon 12	7 N nitrogen 14	8 O oxygen 16	9 F fluorine 19	10 Ne neon 20	
11 Na sodium 23	12 Mg magnesium 24	13 Al aluminium 27	14 Si silicon 28	15 P phosphorus 31	16 S sulfur 32	17 Cl chlorine 35.5	18 Ar argon 40		
19 K potassium 39	20 Ca calcium 40	21 Sc scandium 45	22 Ti titanium 48	23 V vanadium 51	24 Cr chromium 52	25 Mn manganese 55	26 Fe iron 56	27 Co cobalt 59	28 Ni nickel 59
37 Rb rubidium 85	38 Sr strontium 88	39 Y yttrium 89	40 Zr zirconium 91	41 Nb niobium 93	42 Mo molybdenum 96	43 Tc technetium —	44 Ru ruthenium 101	45 Rh rhodium 103	46 Pd palladium 106
55 Cs caesium 133	56 Ba barium 137	57–71 lanthanoids	72 Hf hafnium 178	73 Ta tantalum 181	74 W tungsten 184	75 Re rhenium 186	76 Os osmium 190	77 Ir iridium 192	78 Pt platinum 195
87 Fr francium —	88 Ra radium —	89–103 actinoids	104 Rf rutherfordium —	105 Db dubnium —	106 Sg seaborgium —	107 Bh bohrium —	108 Hs hassium —	109 Mt meitnerium —	110 Ds darmstadtium —
			111 Rg roentgenium —	112 Cn copernicium —	113 Nh nihonium —	114 Fl flerovium —	115 Mc moscovium —	116 Lv livermorium —	117 Ts tennessine —
			118 Og oganesson —	119 Uu unbinilium —	120 Uub unbinilium —	121 Uut unbinilium —	122 Uuq unbinilium —	123 Uuq unbinilium —	124 Uub unbinilium —
			125 Uut unbinilium —	126 Uuq unbinilium —	127 Uuq unbinilium —	128 Uuq unbinilium —	129 Uuq unbinilium —	130 Uuq unbinilium —	131 Xe xenon 131
			132 Uuq unbinilium —	133 Uuq unbinilium —	134 Uuq unbinilium —	135 Uuq unbinilium —	136 Uuq unbinilium —	137 Uuq unbinilium —	138 Xe xenon 131
			139 Uuq unbinilium —	140 Uuq unbinilium —	141 Uuq unbinilium —	142 Uuq unbinilium —	143 Uuq unbinilium —	144 Uuq unbinilium —	145 Xe xenon 131
			146 Uuq unbinilium —	147 Uuq unbinilium —	148 Uuq unbinilium —	149 Uuq unbinilium —	150 Uuq unbinilium —	151 Uuq unbinilium —	152 Xe xenon 131
			153 Uuq unbinilium —	154 Uuq unbinilium —	155 Uuq unbinilium —	156 Uuq unbinilium —	157 Uuq unbinilium —	158 Uuq unbinilium —	159 Xe xenon 131
			160 Uuq unbinilium —	161 Uuq unbinilium —	162 Uuq unbinilium —	163 Uuq unbinilium —	164 Uuq unbinilium —	165 Uuq unbinilium —	166 Xe xenon 131
			167 Uuq unbinilium —	168 Uuq unbinilium —	169 Uuq unbinilium —	170 Uuq unbinilium —	171 Uuq unbinilium —	172 Uuq unbinilium —	173 Xe xenon 131
			173 Uuq unbinilium —	174 Uuq unbinilium —	175 Uuq unbinilium —	176 Uuq unbinilium —	177 Uuq unbinilium —	178 Uuq unbinilium —	179 Xe xenon 131
			179 Uuq unbinilium —	180 Uuq unbinilium —	181 Uuq unbinilium —	182 Uuq unbinilium —	183 Uuq unbinilium —	184 Uuq unbinilium —	185 Xe xenon 131
			185 Uuq unbinilium —	186 Uuq unbinilium —	187 Uuq unbinilium —	188 Uuq unbinilium —	189 Uuq unbinilium —	190 Uuq unbinilium —	191 Xe xenon 131
			191 Uuq unbinilium —	192 Uuq unbinilium —	193 Uuq unbinilium —	194 Uuq unbinilium —	195 Uuq unbinilium —	196 Uuq unbinilium —	197 Xe xenon 131
			197 Uuq unbinilium —	198 Uuq unbinilium —	199 Uuq unbinilium —	200 Uuq unbinilium —	201 Uuq unbinilium —	202 Uuq unbinilium —	203 Xe xenon 131
			203 Uuq unbinilium —	204 Uuq unbinilium —	205 Uuq unbinilium —	206 Uuq unbinilium —	207 Uuq unbinilium —	208 Uuq unbinilium —	209 Xe xenon 131
			209 Uuq unbinilium —	210 Uuq unbinilium —	211 Uuq unbinilium —	212 Uuq unbinilium —	213 Uuq unbinilium —	214 Uuq unbinilium —	215 Xe xenon 131
			215 Uuq unbinilium —	216 Uuq unbinilium —	217 Uuq unbinilium —	218 Uuq unbinilium —	219 Uuq unbinilium —	220 Uuq unbinilium —	221 Xe xenon 131
			221 Uuq unbinilium —	222 Uuq unbinilium —	223 Uuq unbinilium —	224 Uuq unbinilium —	225 Uuq unbinilium —	226 Uuq unbinilium —	227 Xe xenon 131
			227 Uuq unbinilium —	228 Uuq unbinilium —	229 Uuq unbinilium —	230 Uuq unbinilium —	231 Uuq unbinilium —	232 Uuq unbinilium —	233 Xe xenon 131
			233 Uuq unbinilium —	234 Uuq unbinilium —	235 Uuq unbinilium —	236 Uuq unbinilium —	237 Uuq unbinilium —	238 Uuq unbinilium —	239 Xe xenon 131
			239 Uuq unbinilium —	240 Uuq unbinilium —	241 Uuq unbinilium —	242 Uuq unbinilium —	243 Uuq unbinilium —	244 Uuq unbinilium —	245 Xe xenon 131
			245 Uuq unbinilium —	246 Uuq unbinilium —	247 Uuq unbinilium —	248 Uuq unbinilium —	249 Uuq unbinilium —	250 Uuq unbinilium —	251 Xe xenon 131
			251 Uuq unbinilium —	252 Uuq unbinilium —	253 Uuq unbinilium —	254 Uuq unbinilium —	255 Uuq unbinilium —	256 Uuq unbinilium —	257 Xe xenon 131
			257 Uuq unbinilium —	258 Uuq unbinilium —	259 Uuq unbinilium —	260 Uuq unbinilium —	261 Uuq unbinilium —	262 Uuq unbinilium —	263 Xe xenon 131
			263 Uuq unbinilium —	264 Uuq unbinilium —	265 Uuq unbinilium —	266 Uuq unbinilium —	267 Uuq unbinilium —	268 Uuq unbinilium —	269 Xe xenon 131
			269 Uuq unbinilium —	270 Uuq unbinilium —	271 Uuq unbinilium —	272 Uuq unbinilium —	273 Uuq unbinilium —	274 Uuq unbinilium —	275 Xe xenon 131
			275 Uuq unbinilium —	276 Uuq unbinilium —	277 Uuq unbinilium —	278 Uuq unbinilium —	279 Uuq unbinilium —	280 Uuq unbinilium —	281 Xe xenon 131
			281 Uuq unbinilium —	282 Uuq unbinilium —	283 Uuq unbinilium —	284 Uuq unbinilium —	285 Uuq unbinilium —	286 Uuq unbinilium —	287 Xe xenon 131
			287 Uuq unbinilium —	288 Uuq unbinilium —	289 Uuq unbinilium —	290 Uuq unbinilium —	291 Uuq unbinilium —	292 Uuq unbinilium —	293 Xe xenon 131
			293 Uuq unbinilium —	294 Uuq unbinilium —	295 Uuq unbinilium —	296 Uuq unbinilium —	297 Uuq unbinilium —	298 Uuq unbinilium —	299 Xe xenon 131
			299 Uuq unbinilium —	300 Uuq unbinilium —	301 Uuq unbinilium —	302 Uuq unbinilium —	303 Uuq unbinilium —	304 Uuq unbinilium —	305 Xe xenon 131
			305 Uuq unbinilium —	306 Uuq unbinilium —	307 Uuq unbinilium —	308 Uuq unbinilium —	309 Uuq unbinilium —	310 Uuq unbinilium —	311 Xe xenon 131
			311 Uuq unbinilium —	312 Uuq unbinilium —	313 Uuq unbinilium —	314 Uuq unbinilium —	315 Uuq unbinilium —	316 Uuq unbinilium —	317 Xe xenon 131
			317 Uuq unbinilium —	318 Uuq unbinilium —	319 Uuq unbinilium —	320 Uuq unbinilium —	321 Uuq unbinilium —	322 Uuq unbinilium —	323 Xe xenon 131
			323 Uuq unbinilium —	324 Uuq unbinilium —	325 Uuq unbinilium —	326 Uuq unbinilium —	327 Uuq unbinilium —	328 Uuq unbinilium —	329 Xe xenon 131
			329 Uuq unbinilium —	330 Uuq unbinilium —	331 Uuq unbinilium —	332 Uuq unbinilium —	333 Uuq unbinilium —	334 Uuq unbinilium —	335 Xe xenon 131
			335 Uuq unbinilium —	336 Uuq unbinilium —	337 Uuq unbinilium —	338 Uuq unbinilium —	339 Uuq unbinilium —	340 Uuq unbinilium —	341 Xe xenon 131
			341 Uuq unbinilium —	342 Uuq unbinilium —	343 Uuq unbinilium —	344 Uuq unbinilium —	345 Uuq unbinilium —	346 Uuq unbinilium —	347 Xe xenon 131
			347 Uuq unbinilium —	348 Uuq unbinilium —	349 Uuq unbinilium —	350 Uuq unbinilium —	351 Uuq unbinilium —	352 Uuq unbinilium —	353 Xe xenon 131
			353 Uuq unbinilium —	354 Uuq unbinilium —	355 Uuq unbinilium —	356 Uuq unbinilium —	357 Uuq unbinilium —	358 Uuq unbinilium —	359 Xe xenon 131
			359 Uuq unbinilium —	360 Uuq unbinilium —	361 Uuq unbinilium —	362 Uuq unbinilium —	363 Uuq unbinilium —	364 Uuq unbinilium —	365 Xe xenon 131
			365 Uuq unbinilium —	366 Uuq unbinilium —	367 Uuq unbinilium —	368 Uuq unbinilium —	369 Uuq unbinilium —	370 Uuq unbinilium —	371 Xe xenon 131
			371 Uuq unbinilium —	372 Uuq unbinilium —	373 Uuq unbinilium —	374 Uuq unbinilium —	375 Uuq unbinilium —	376 Uuq unbinilium —	377 Xe xenon 131
			377 Uuq unbinilium —	378 Uuq unbinilium —	379 Uuq unbinilium —	380 Uuq unbinilium —	381 Uuq unbinilium —	382 Uuq unbinilium —	383 Xe xenon 131
			383 Uuq unbinilium —	384 Uuq unbinilium —	385 Uuq unbinilium —	386 Uuq unbinilium —	387 Uuq unbinilium —	388 Uuq unbinilium —	389 Xe xenon 131
			389 Uuq unbinilium —	390 Uuq unbinilium —	391 Uuq unbinilium —	392 Uuq unbinilium —	393 Uuq unbinilium —	394 Uuq unbinilium —	395 Xe xenon 131
			395 Uuq unbinilium —	396 Uuq unbinilium —	397 Uuq unbinilium —	398 Uuq unbinilium —	399 Uuq unbinilium —	400 Uuq unbinilium —	401 Xe xenon 131
			401 Uuq unbinilium —	402 Uuq unbinilium —	403 Uuq unbinilium —	404 Uuq unbinilium —	405 Uuq unbinilium —	406 Uuq unbinilium —	407 Xe xenon 131
			407 Uuq unbinilium —	408 Uuq unbinilium —	409 Uuq unbinilium —	410 Uuq unbinilium —	411 Uuq unbinilium —	412 Uuq unbinilium —	413 Xe xenon 131
			413 Uuq unbinilium —	414 Uuq unbinil					